

# Data Sheet



Article number: 03449180

Description: Fluro Heavy Duty Spherical Plain Bearing GE 180 SWE  
Hole Ø180

Note: 180

## Measures

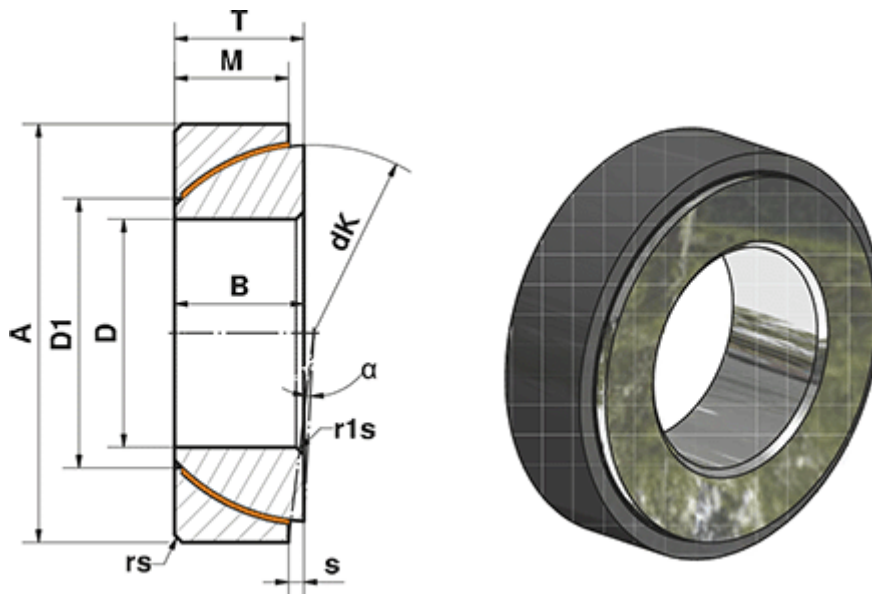

A	= 280	rs, r1s min	= 3
a (degrees)	= 1	S	= 21
B	= 64	Static load C0 (kN)	= 6536
D	= 180	T	= 64
D1	= 206.4	Weight (g)	= 17400
dK	= 260		
Dynamic load C (kN)	= 3922		
M	= 61		